

Body & Tire Karosserie & Reifen
 Carrosserie & Pneu
 Cuerpo & Neumático
 车身及轮胎 ボディとタイヤ

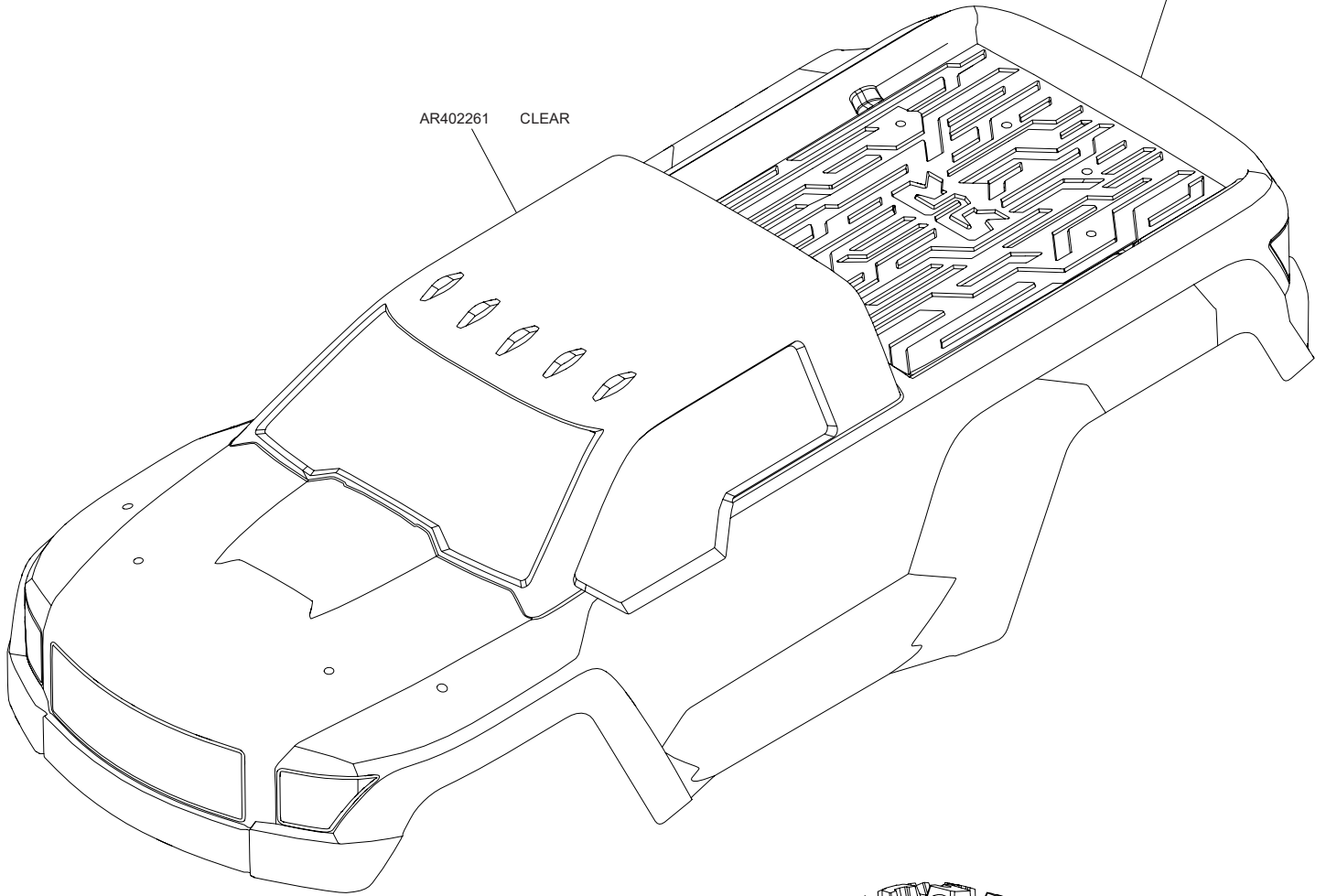

- AR402208 ORANGE / BLACK
- ARA402209 RED / BLUE
- AR402253 GREEN / BLACK
- AR402256 RED / BLACK



AR402261 CLEAR

- PRE GLUED
- AR550044 BLACK
 - AR550045 BLACK CHROME

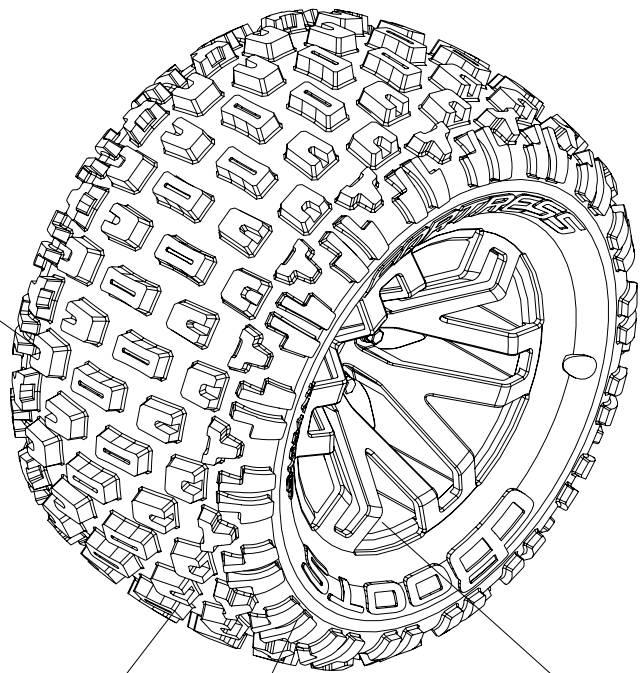

TIRE
AR520045

INSERT
AR530065

WHEELS
AR510097 BLACK
AR510099 BLACK CHROME



Front Vorne Avant Delantero フロント 前

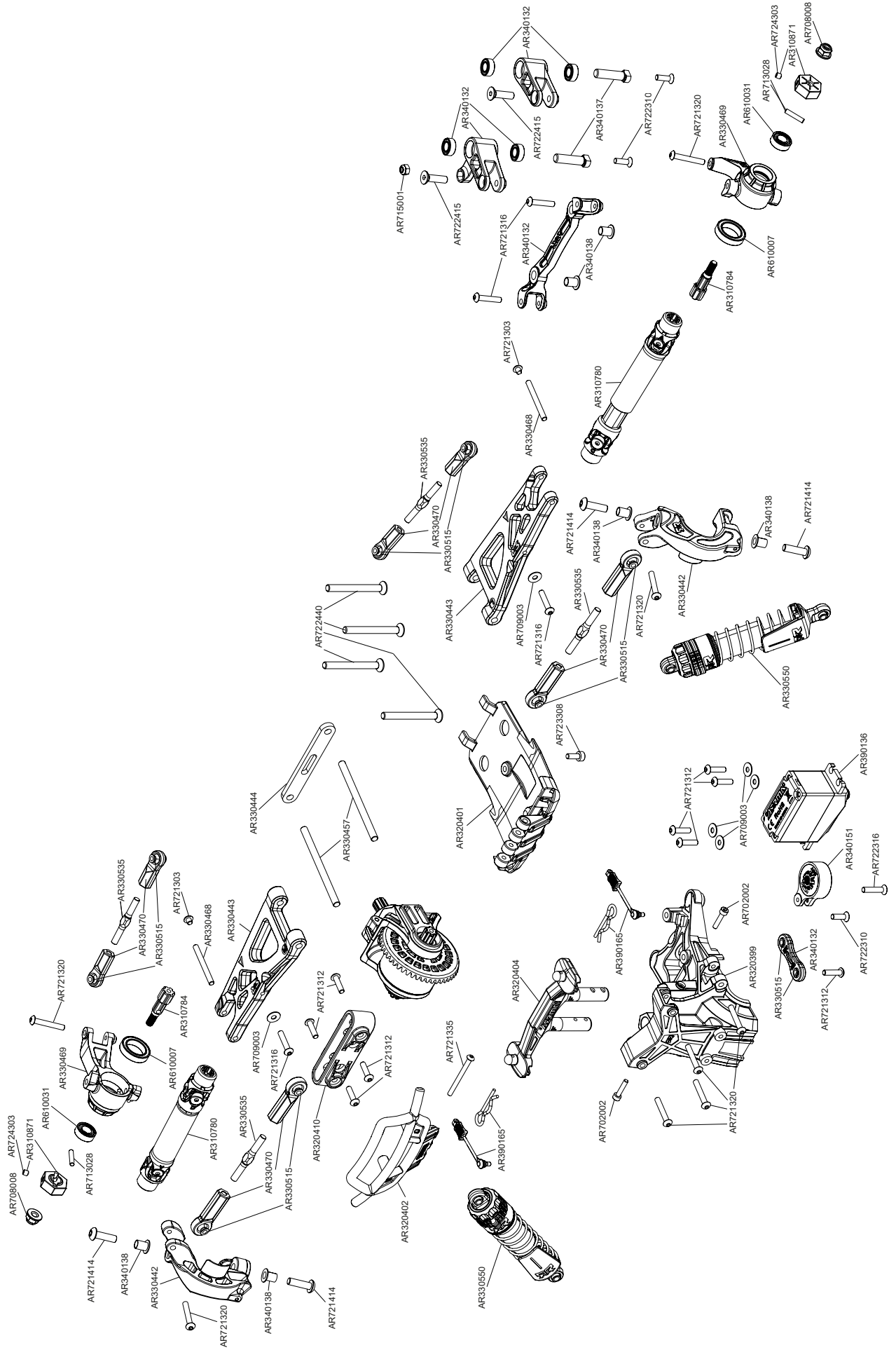

Centre Center
 Centre Centro
 センター 中心

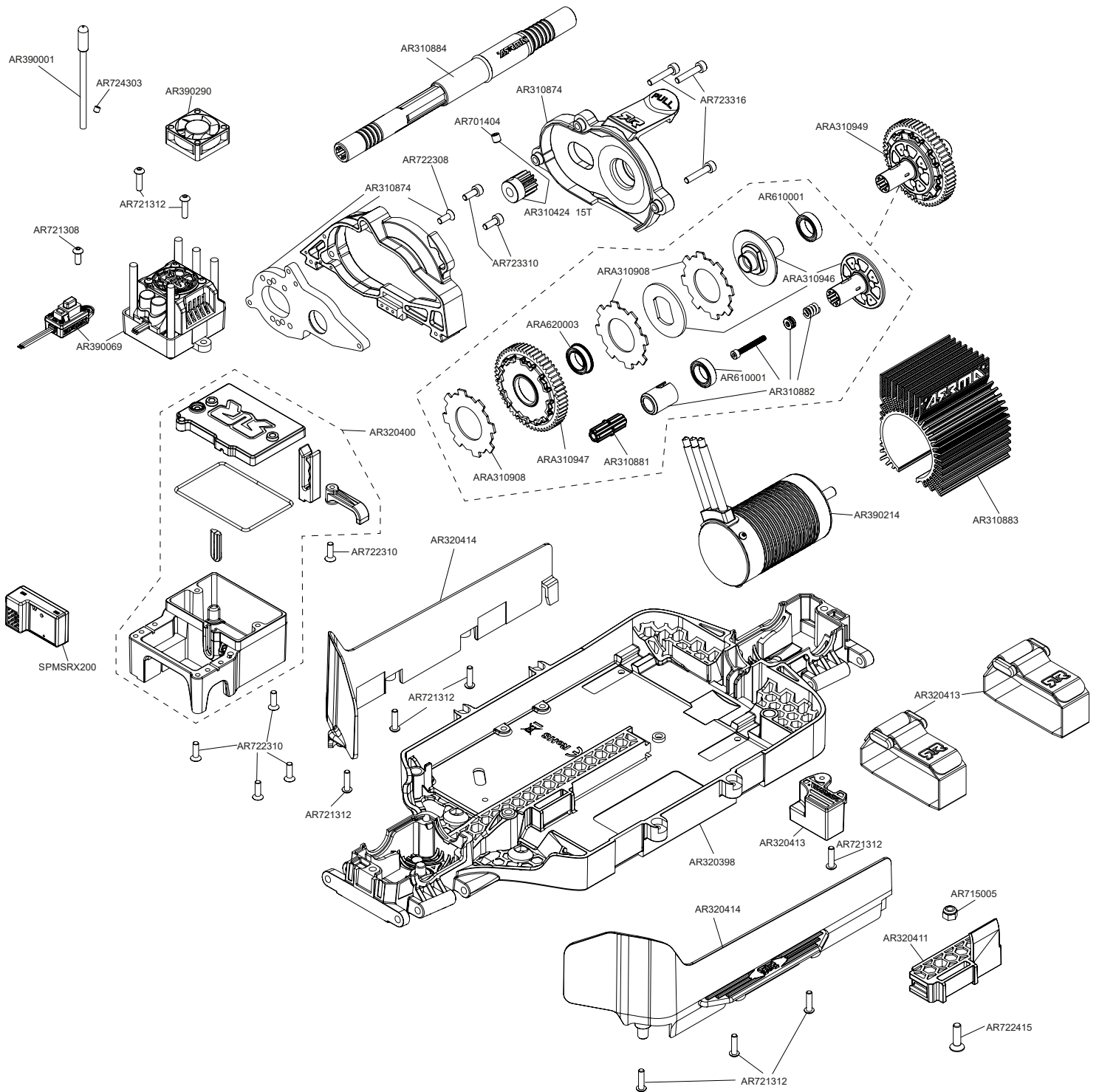

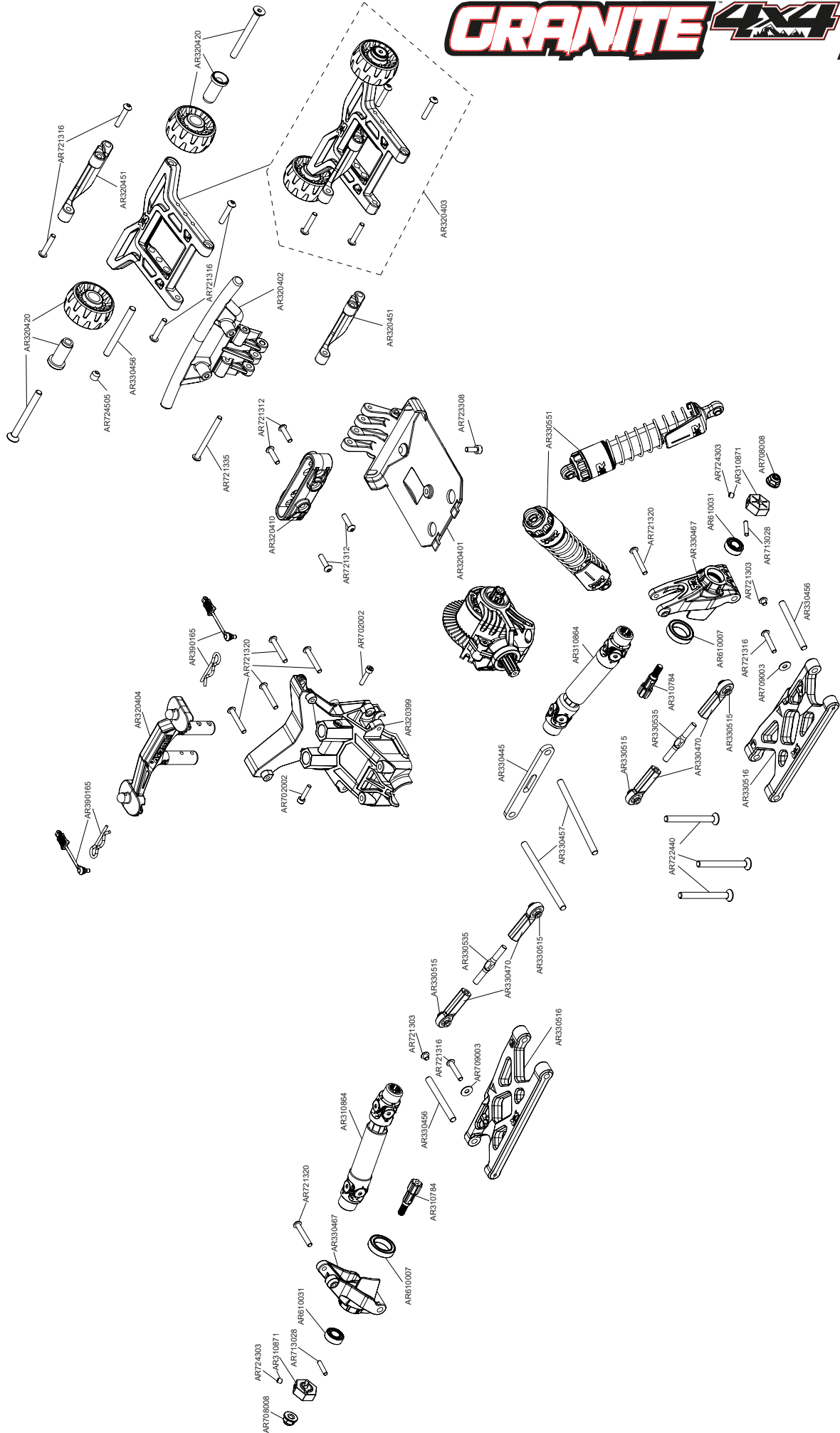

Rear Hinten Arrière Trasero リア后

Differential Differential Différentiel
Diferencial 差动 差動

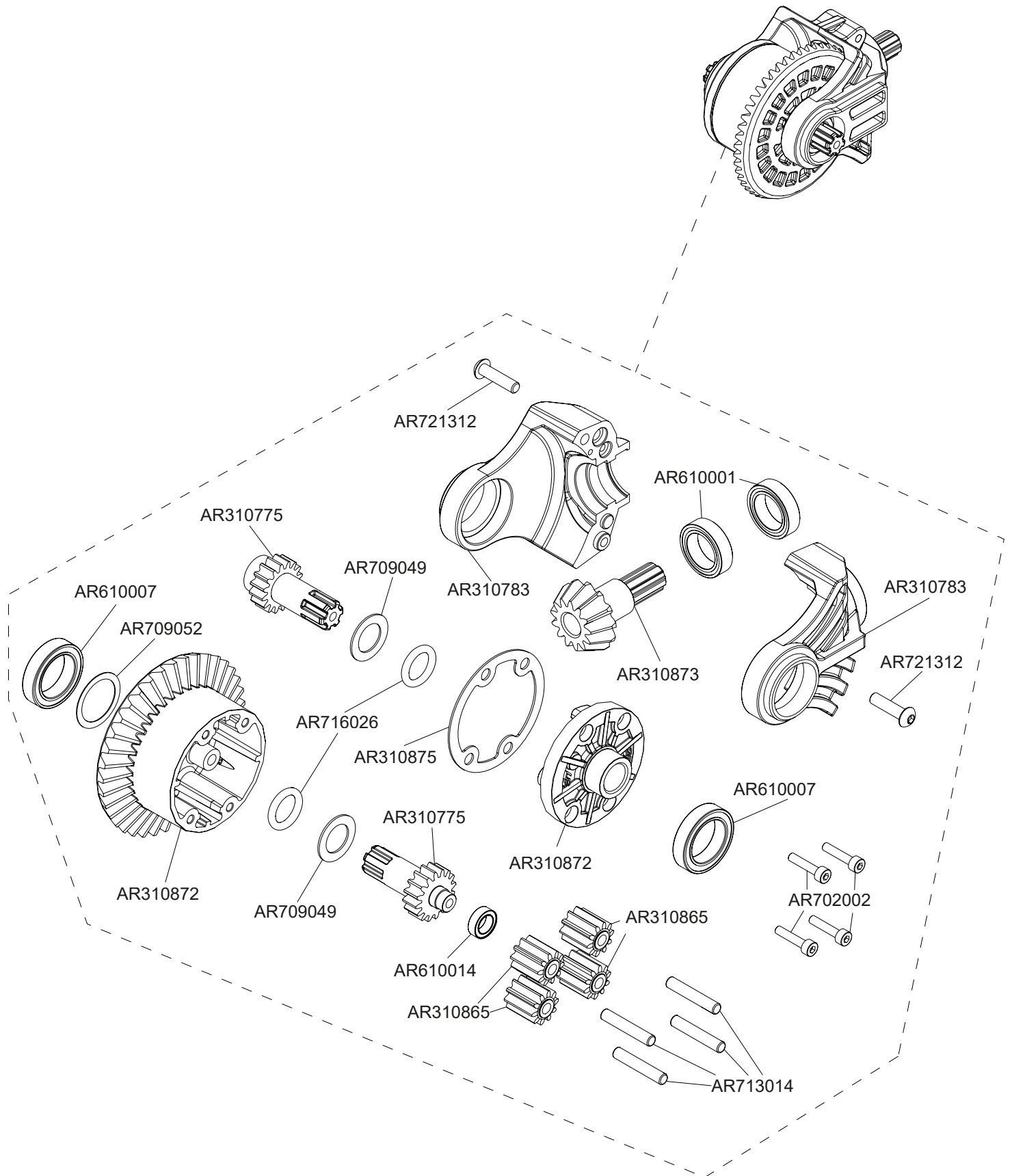

Shocks Stoßdämpfer Amortisseur
Amortiguador 減震器 ショックアブソーバ

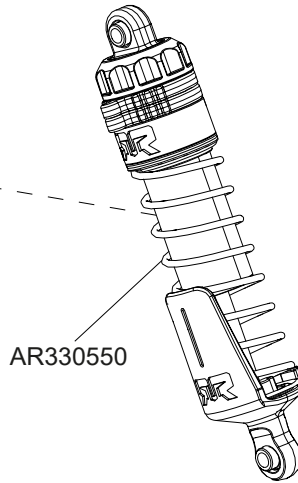
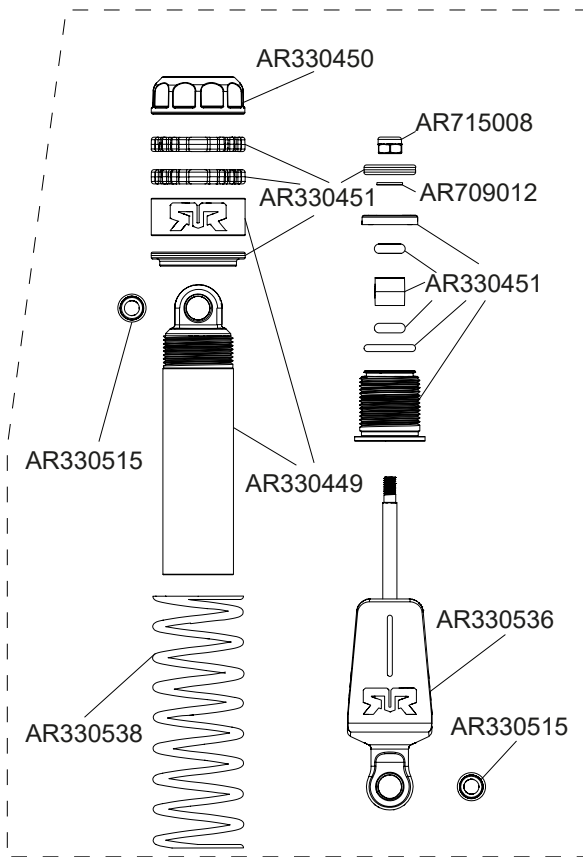

Front Vorne Avant
Delantero フロント 前

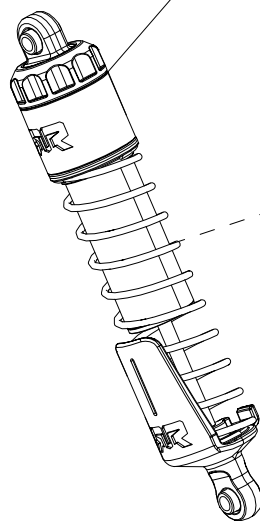
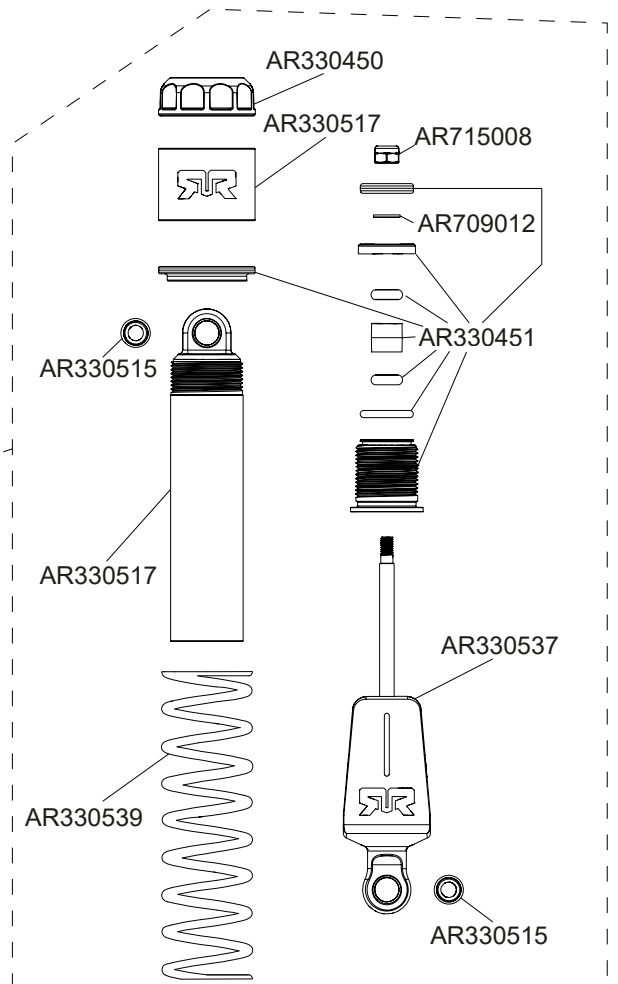

Rear Hinten Arrière
Trasero リア后